

Derek, INTERIOR CONCEPT

8827 Staples Mill Rd | Richmond VA

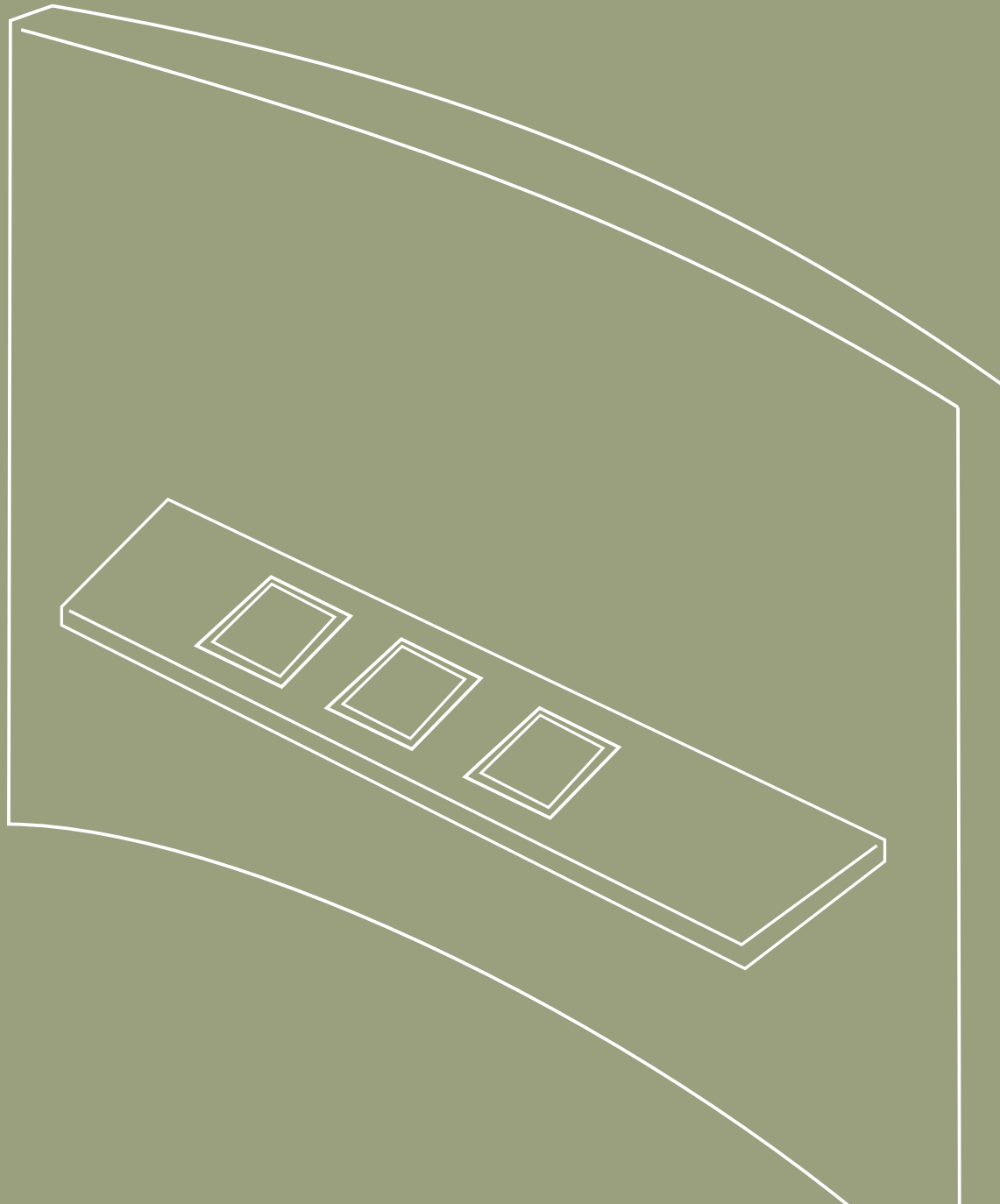

Office Technology Suites



Technology, Comfort & Consultation

The Office Technology Suite concept will elevate the customer experience. The prospect/client will have the ability to compare print speeds, determine the best quality and see finishing options within a customized space, while receiving uninterrupted attention.

Each suite will be branded according to the manufacturer using the manufacturer's images and other marketing materials.

The suites will be furnished with comfortable seating to provide personal consultation in a comfortable environment.

To best achieve the technology suite concept several changes need to be made to the current demo room.

- 1. Remove outdated PCs and replace with tablets**
- 2. Add mobile partitions to create isolated suites**
- 3. Change wall paint and flooring**
- 4. Mount web enabled televisions**
- 5. Re-purpose hallway door**

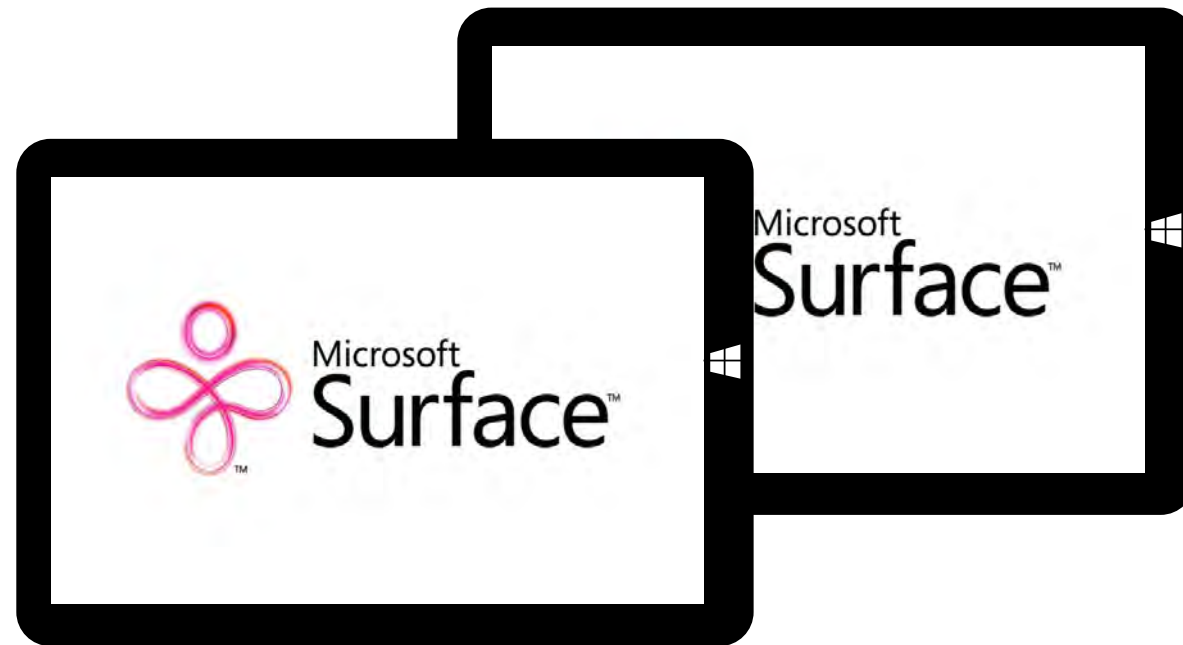

Eliminate desktop PCs, and replace with Windows Surface 3 devices that seamlessly integrate to Cobb's network.

The sales rep will meet the prospect/client with the tablet and escort them to the correct manufacturer suite.

For demos that are pre-planned, it is critical the sales representative and technical support work together to load files and test before demoing technology.

Each tablet will have pre-loaded or "canned files" for unannounced walk in demonstrations.



Front Side



Back Side



The Kyocera "Triangle" includes MFPs and desktops placed neatly on both sides of the column. The columns will be stripped of the current molding and decorated with 4ft X 18 inch panels which display the Kyocera logo and or Kyocera marketing images.

The purpose is to provide a clean demo space, reducing the amount of machines around the columns.

The "triangle" concept is derived from the makeup of the Kyocera logo.

Far Right Corner

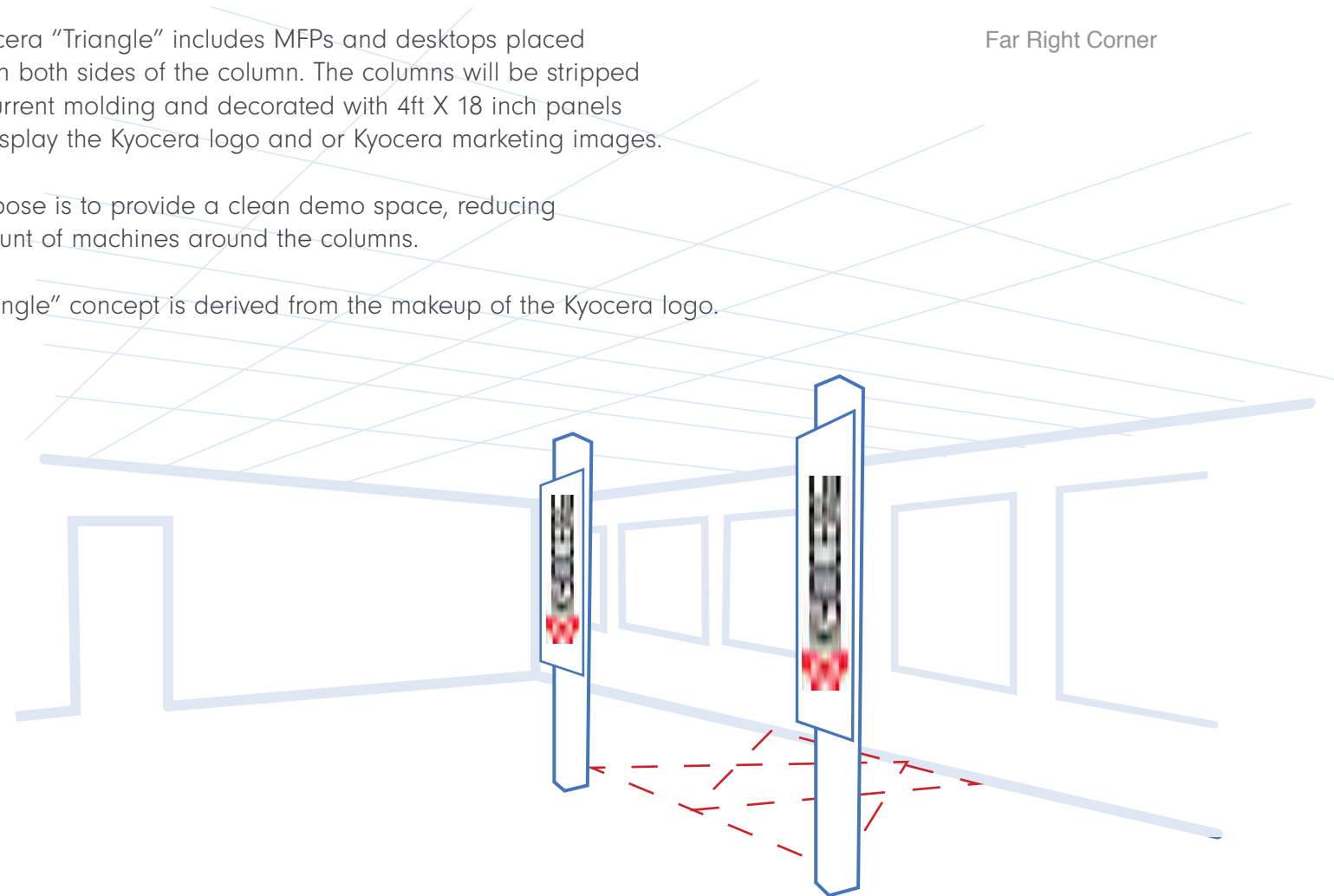

Technology, Comfort & Consultation

8827 Staples Mill Rd | Richmond, VA



The technology suites are divided by mobile partitions. Using mobile partitions allows the space to be divided into multiple configurations.

The suites would contain devices of different speeds and configurations. As well as desktop and wide format devices.



Technology, Comfort & Consultation

Flooring:

Change to tiled carpet with a dynamic pattern.
Or a mix of laminate wood and tiled carpet.

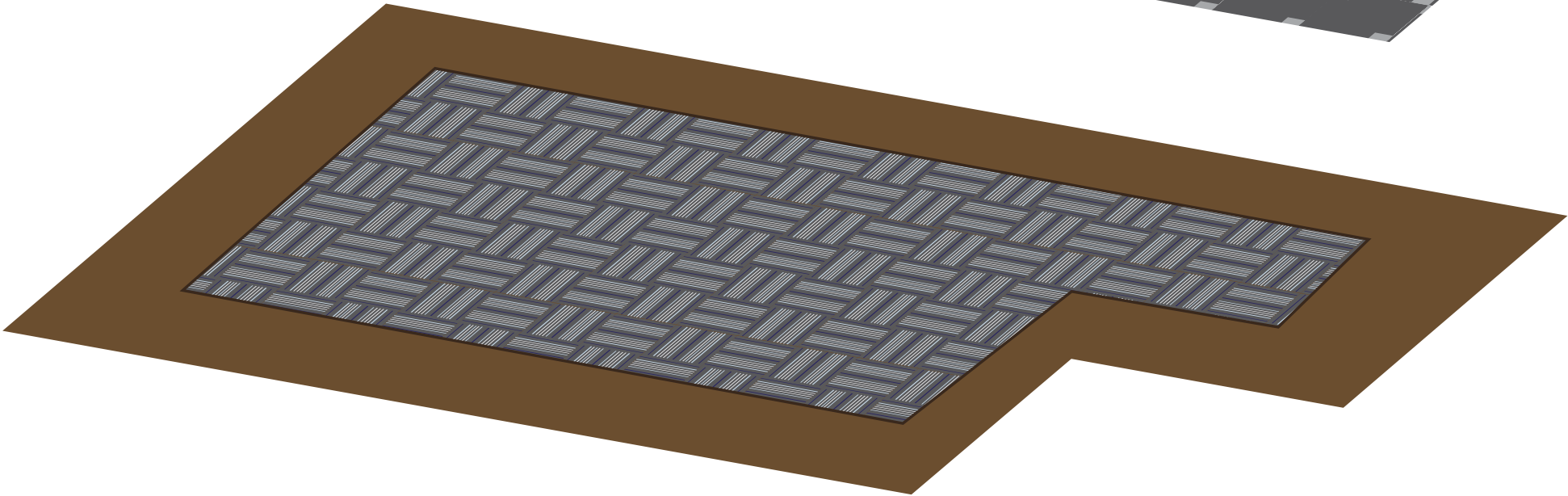
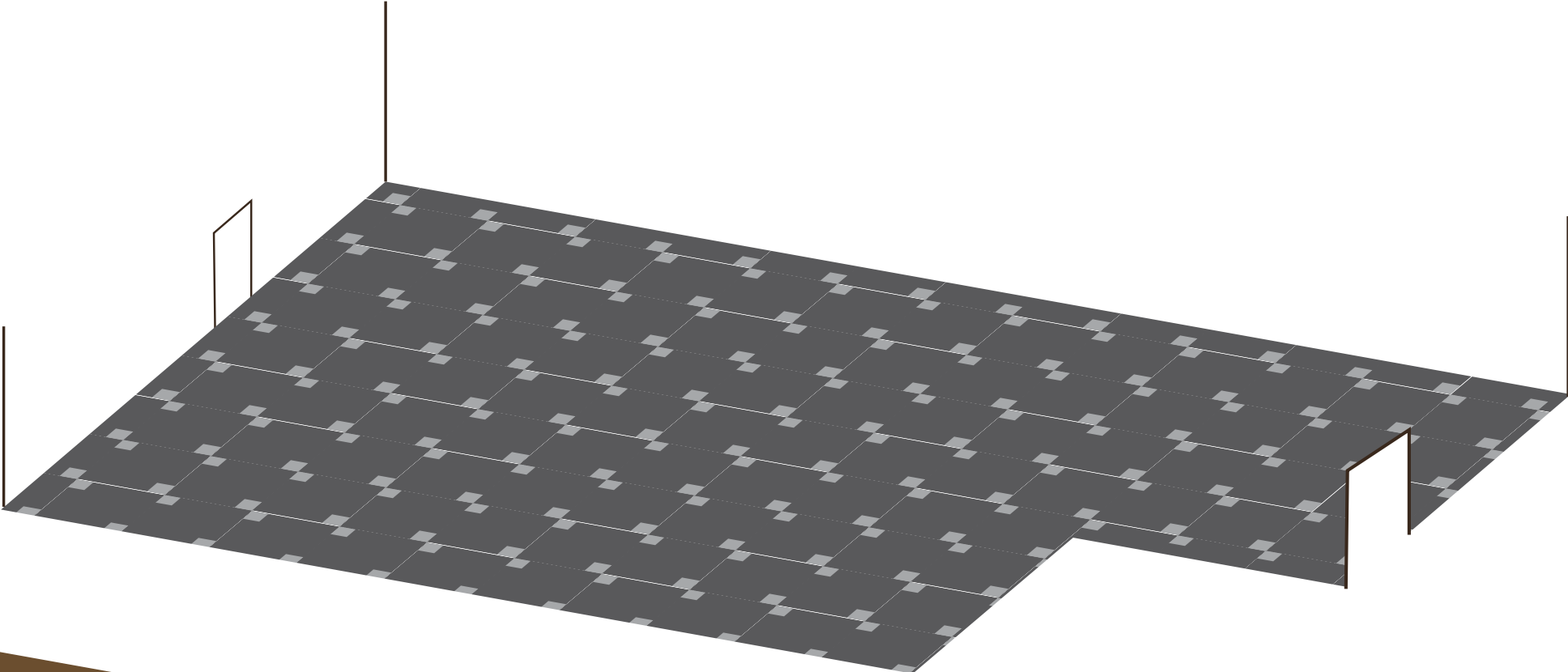

Hallway

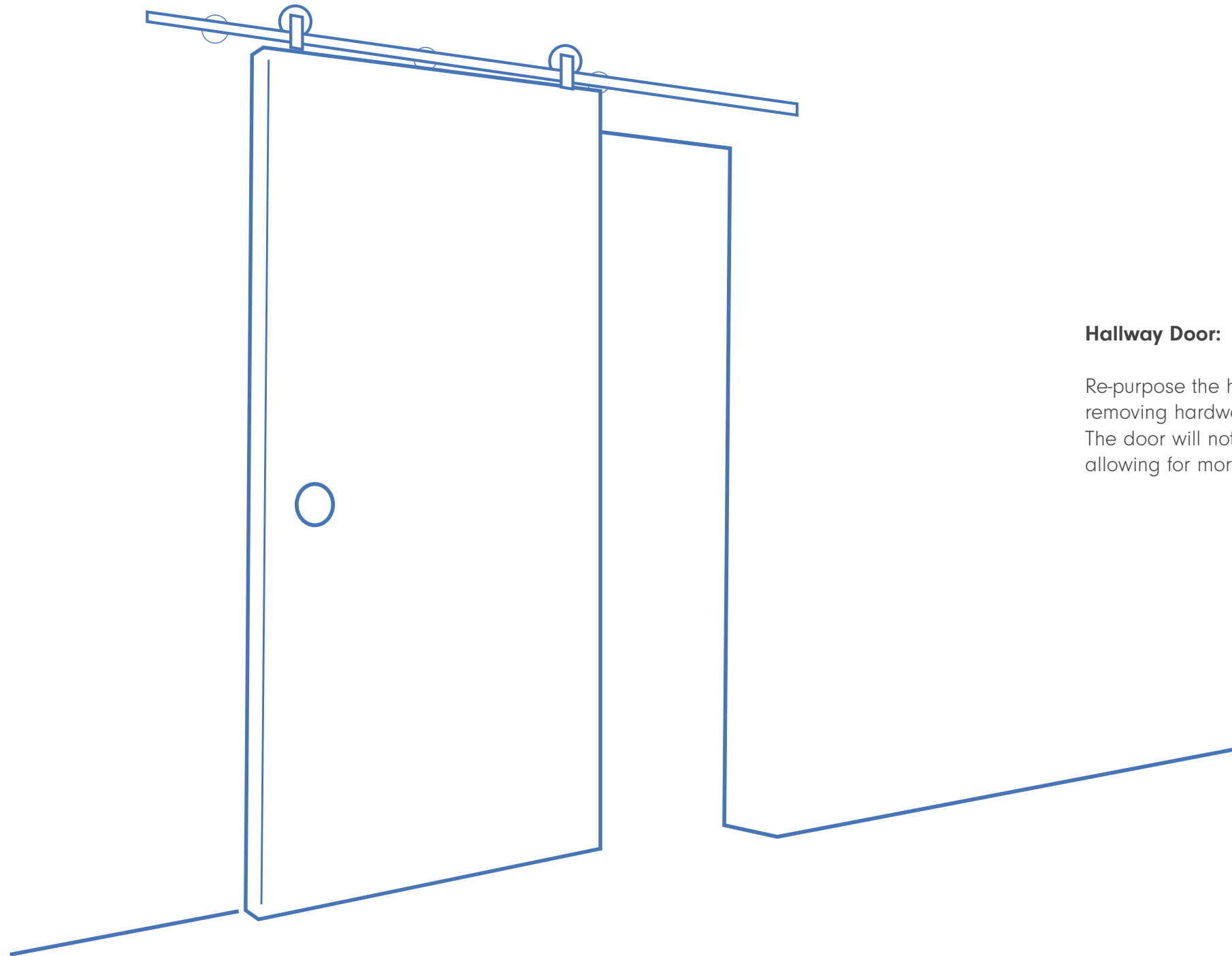

Hallway Door:

Re-purpose the hallway door by removing hardware and converting to a sliding door. The door will not open into the showroom, allowing for more space to be used.



Walls:

Adding a brighter color, texture or dynamic wall graphic would improve the space.

Art is for reference only.

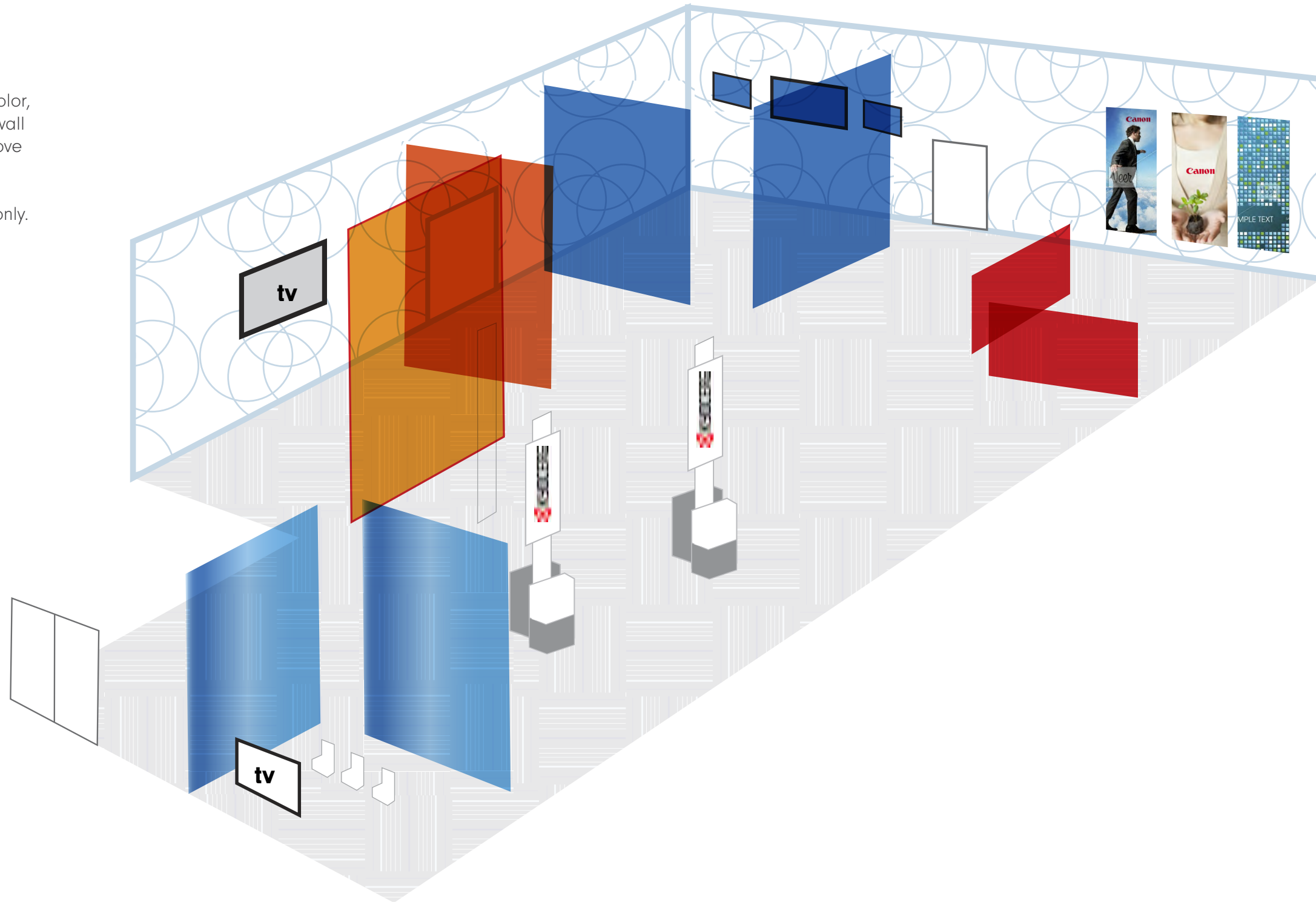

Example of Canon suite with partition.

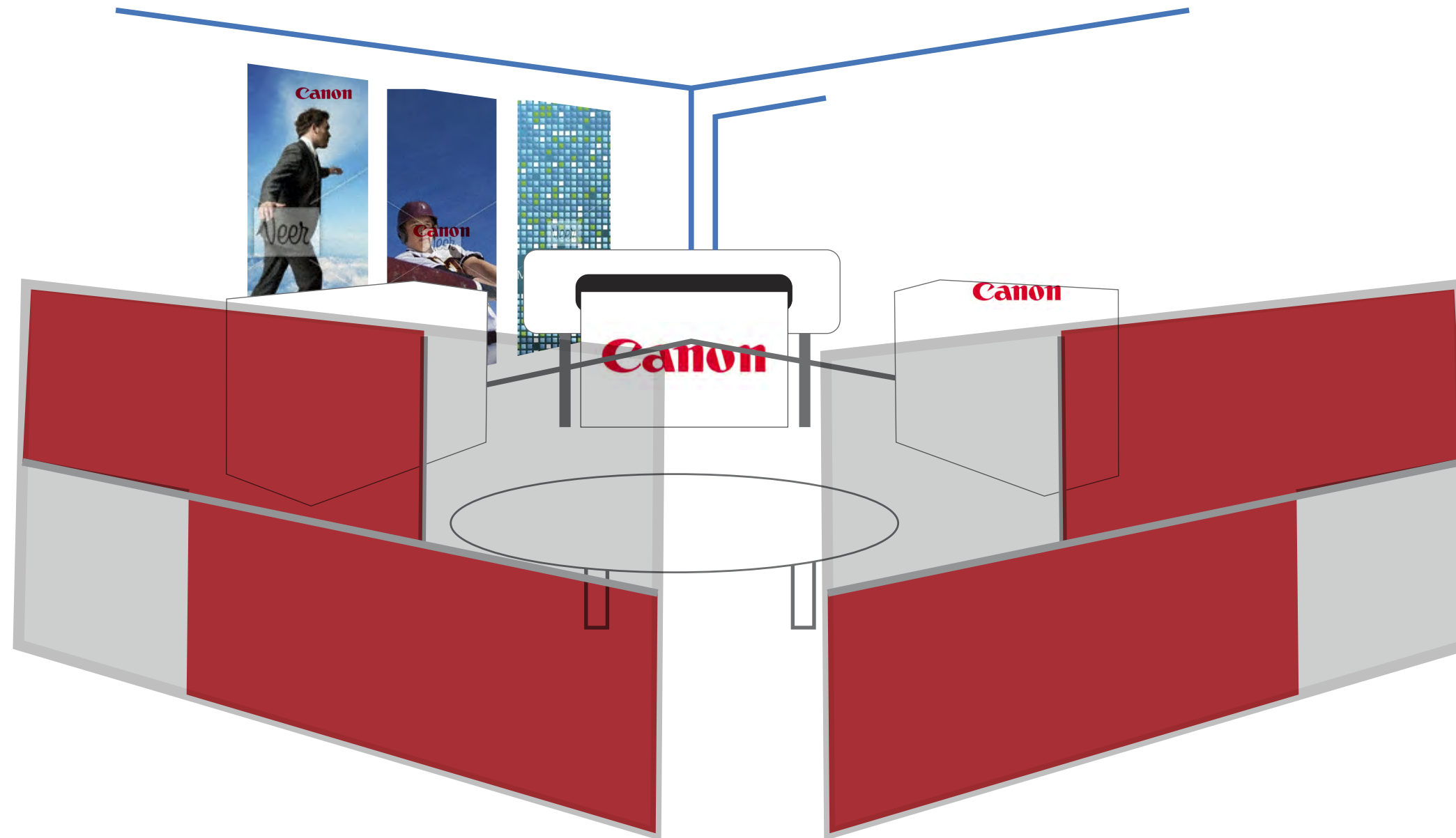

Technology, Comfort & Consultation

8827 Staples Mill Rd | Richmond, VA

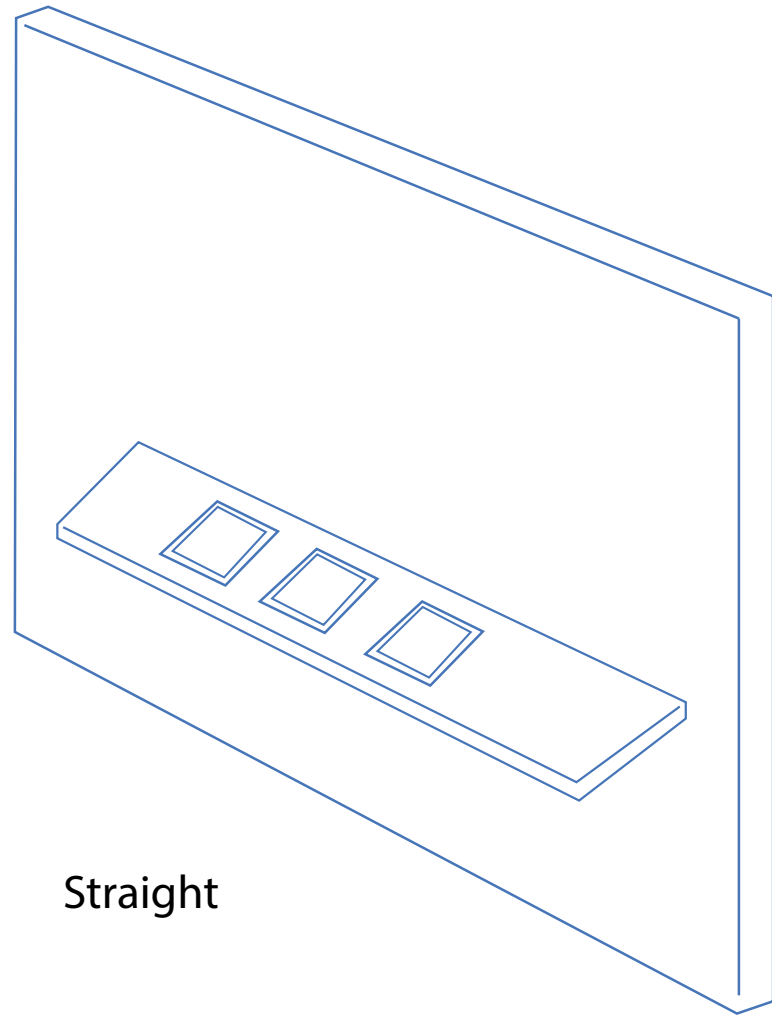

Straight

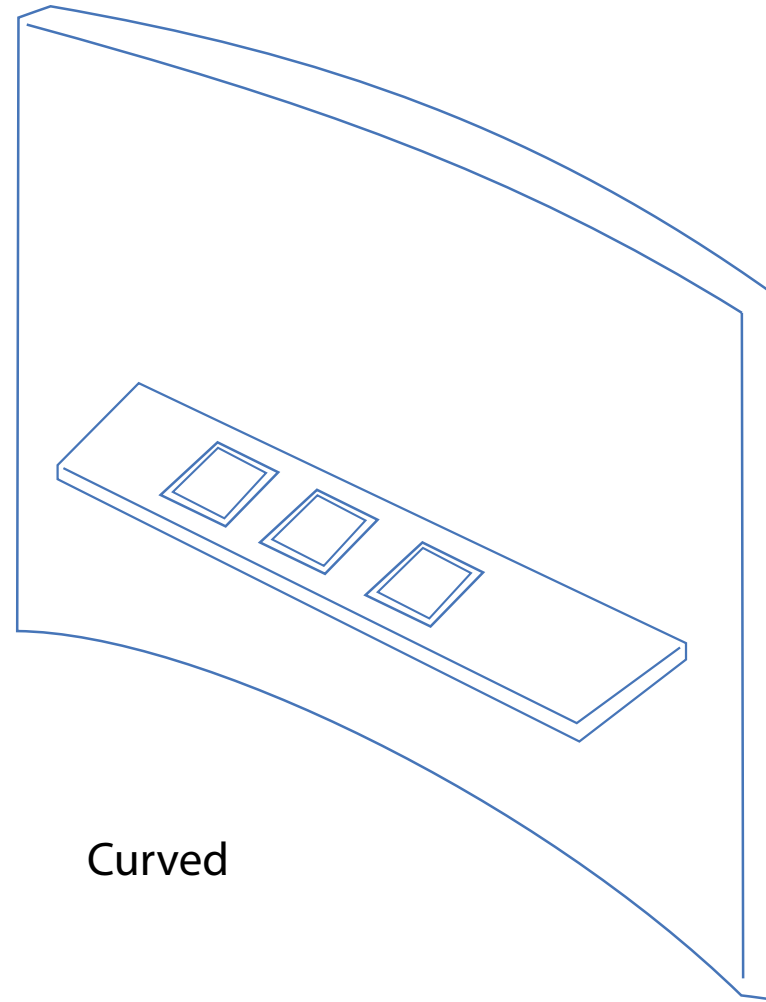

Curved

Partition holding tablets and displays company logo or graphic.

